

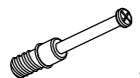

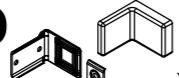

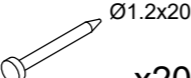

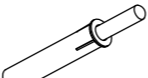

B  Ø15 x16	C  Ø8 x16	D  x2	G  Ø1.2x20 x20	I  x2
K  x4	O1  Ø20 x8	O2  Ø14 x10	Q  x4	T  x4
W1  Ø4x16 x12	W2  Ø4x30 x3	Z  x4		



2

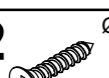

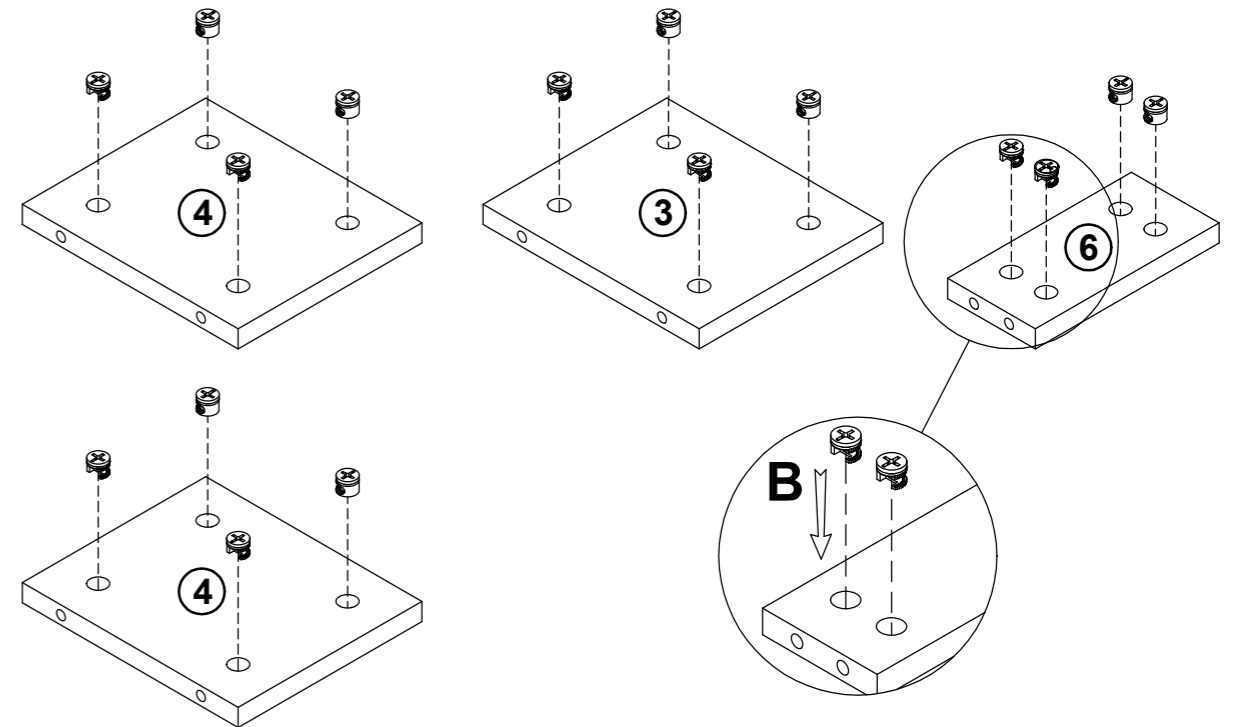
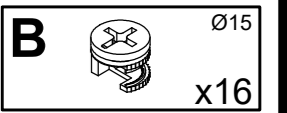
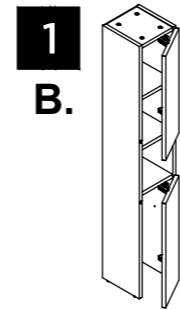
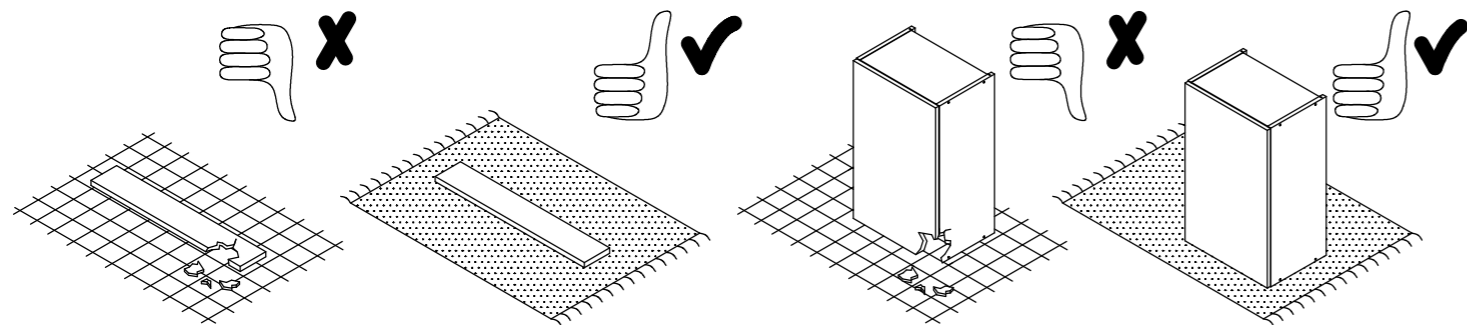
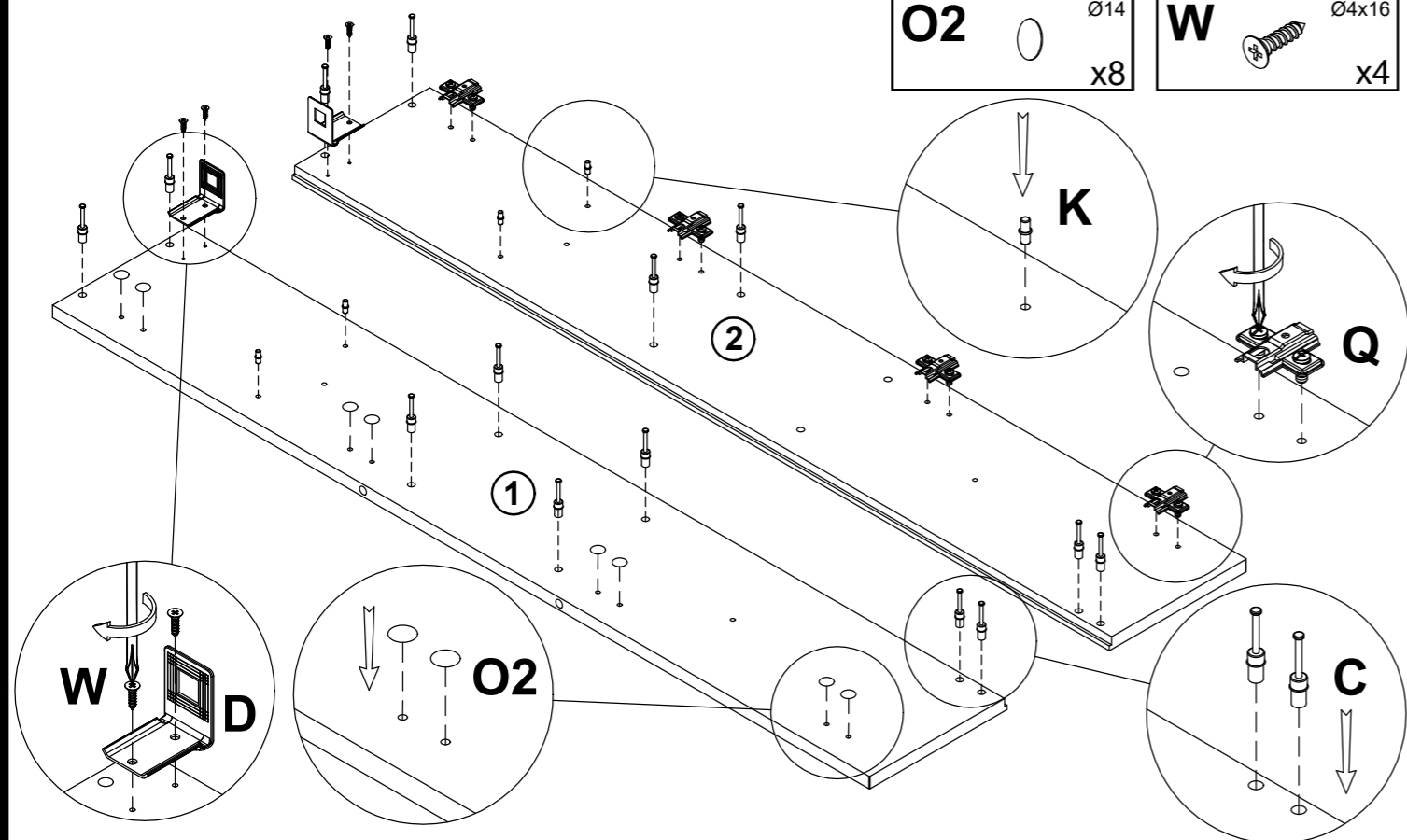
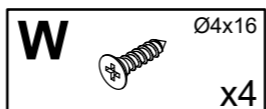
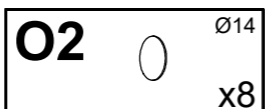
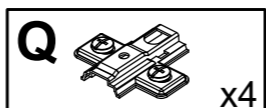
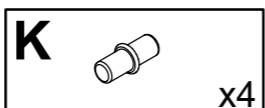
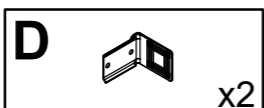
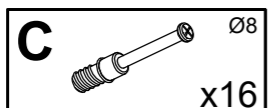
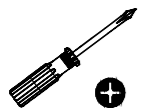
3

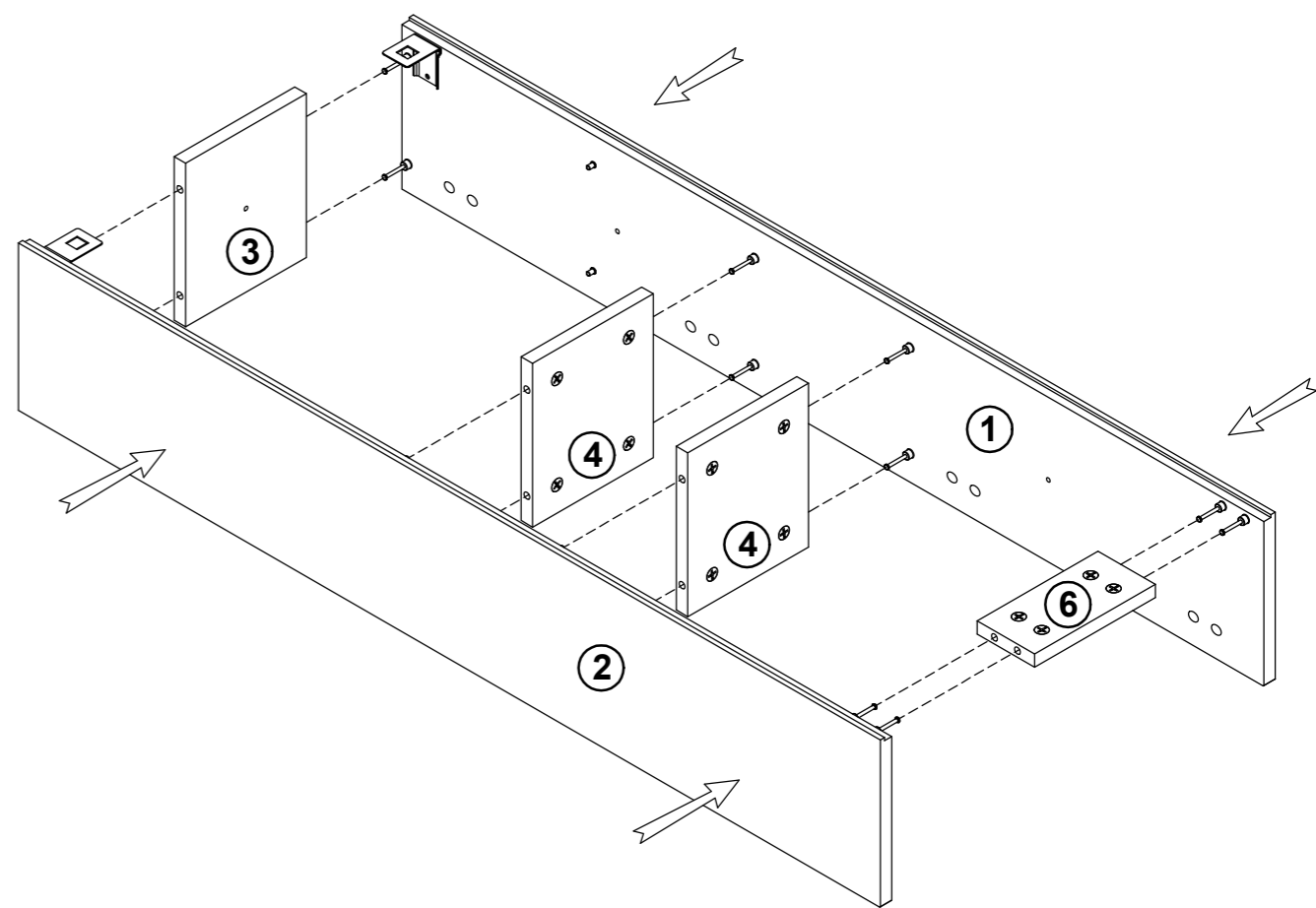

4

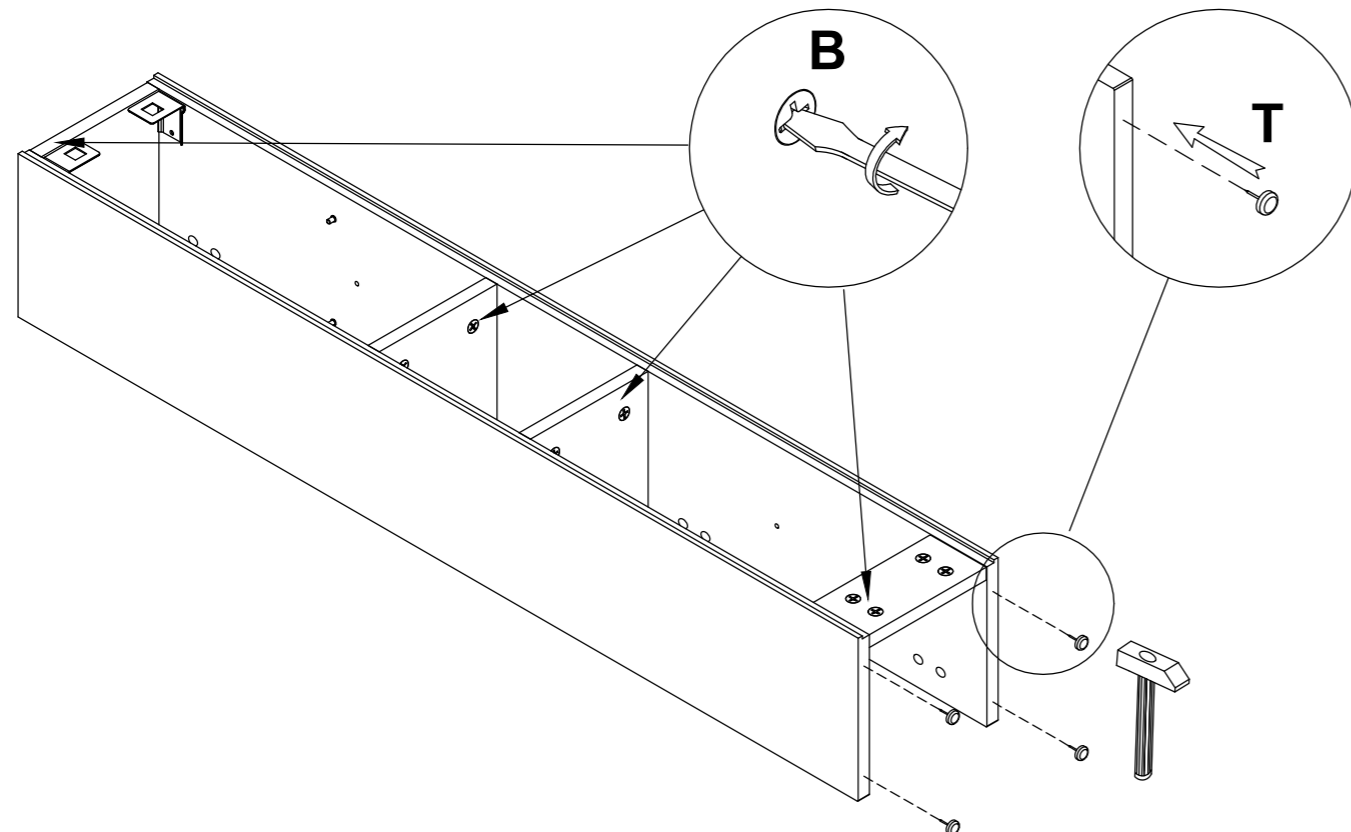
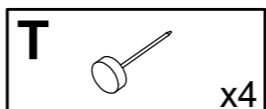
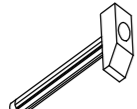
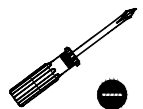

5

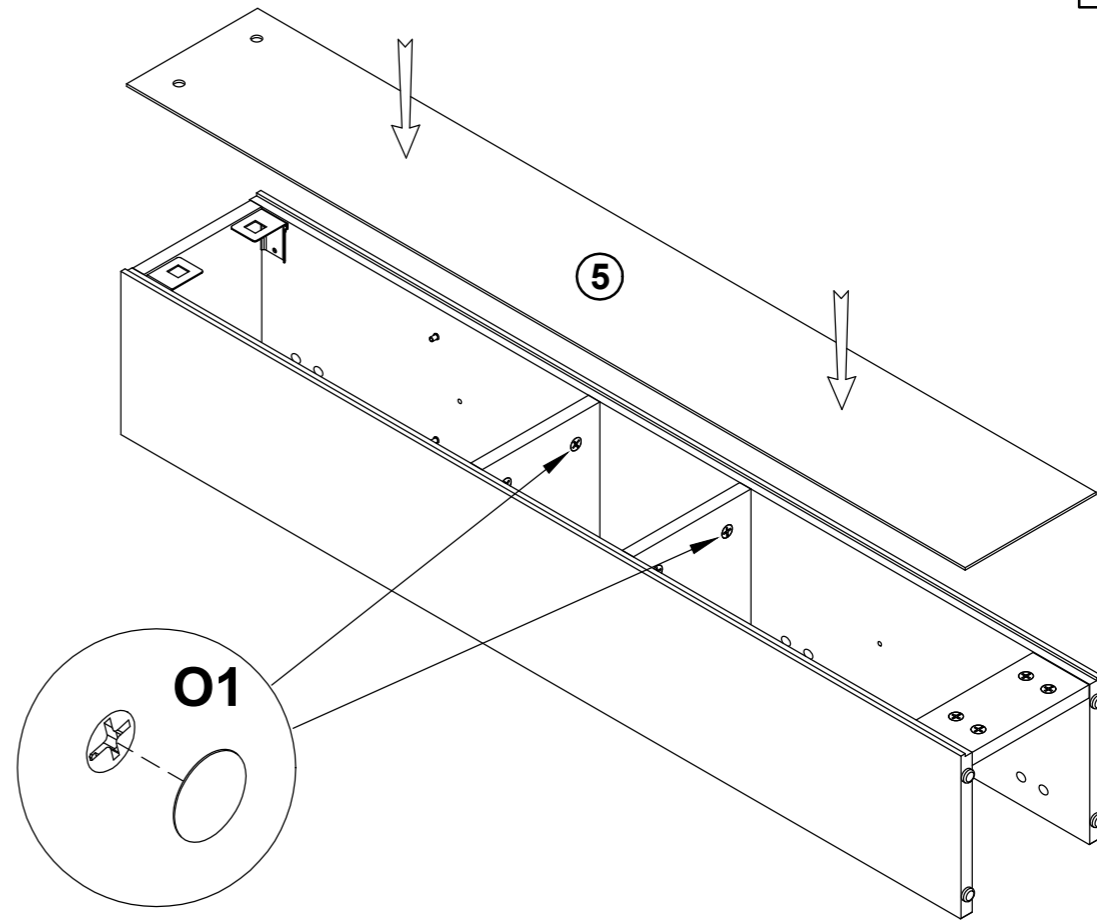
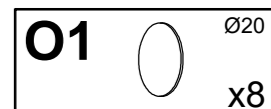

6

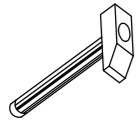

A=B

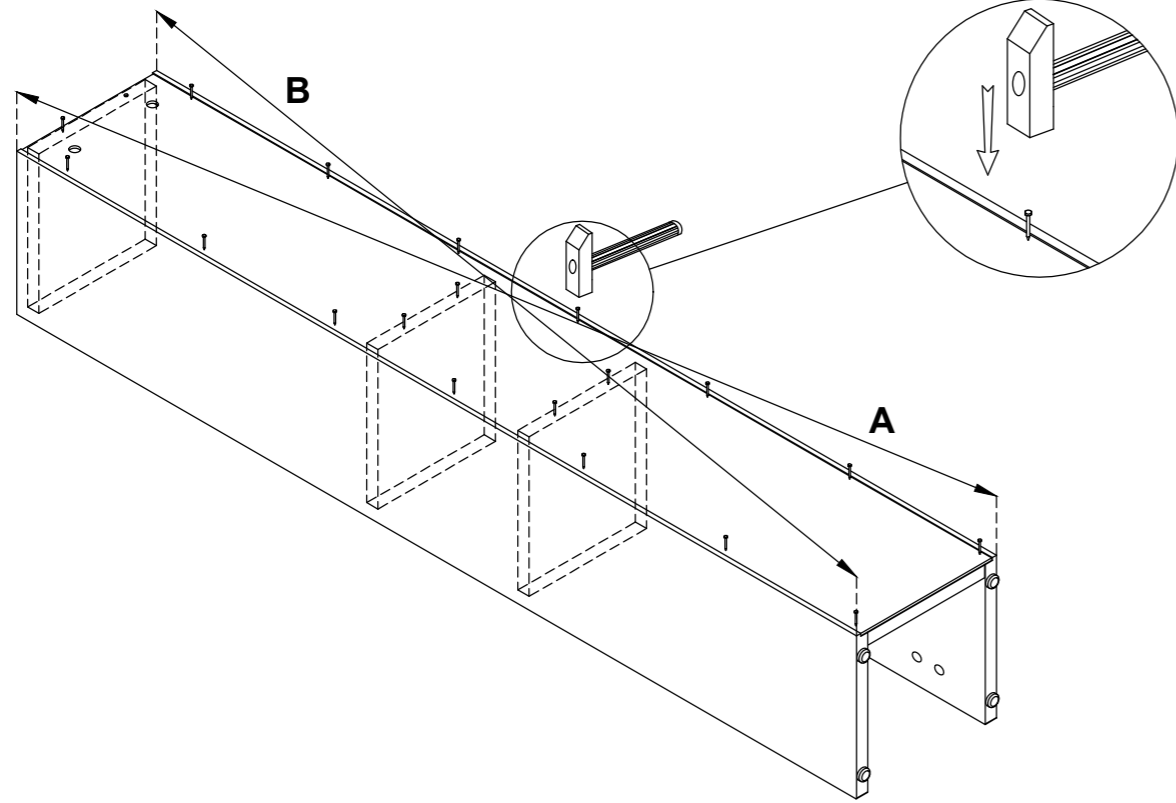

G

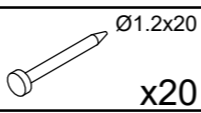

Ø1.2x20
x20

7

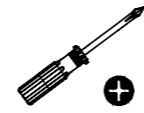

W1

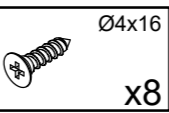

Ø4x16
x8

Z

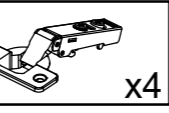

x4

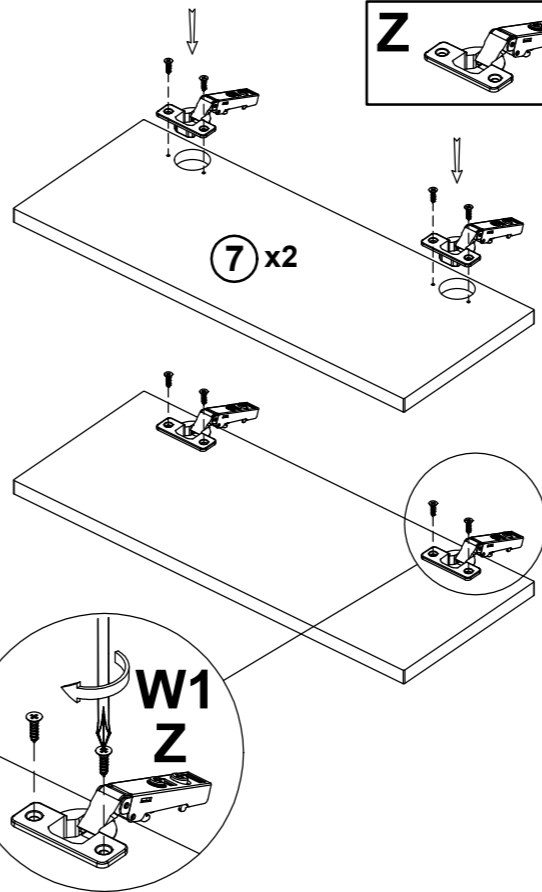

8

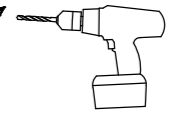
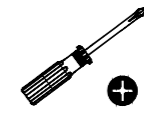

D

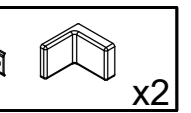

x2

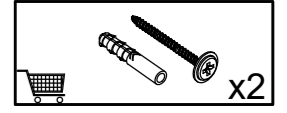

x2

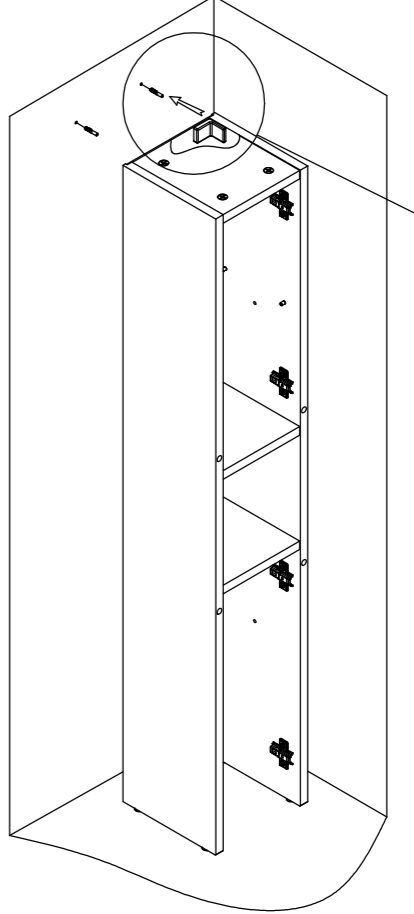

9

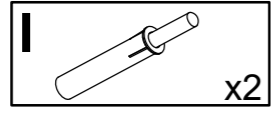

x2

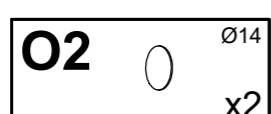

Ø14
x2

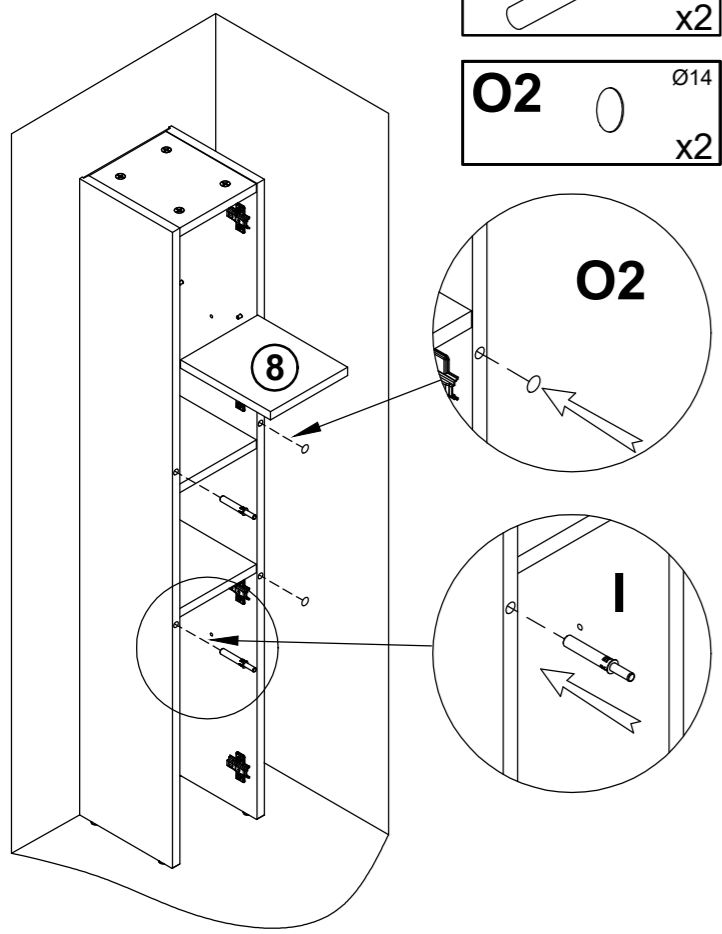

10

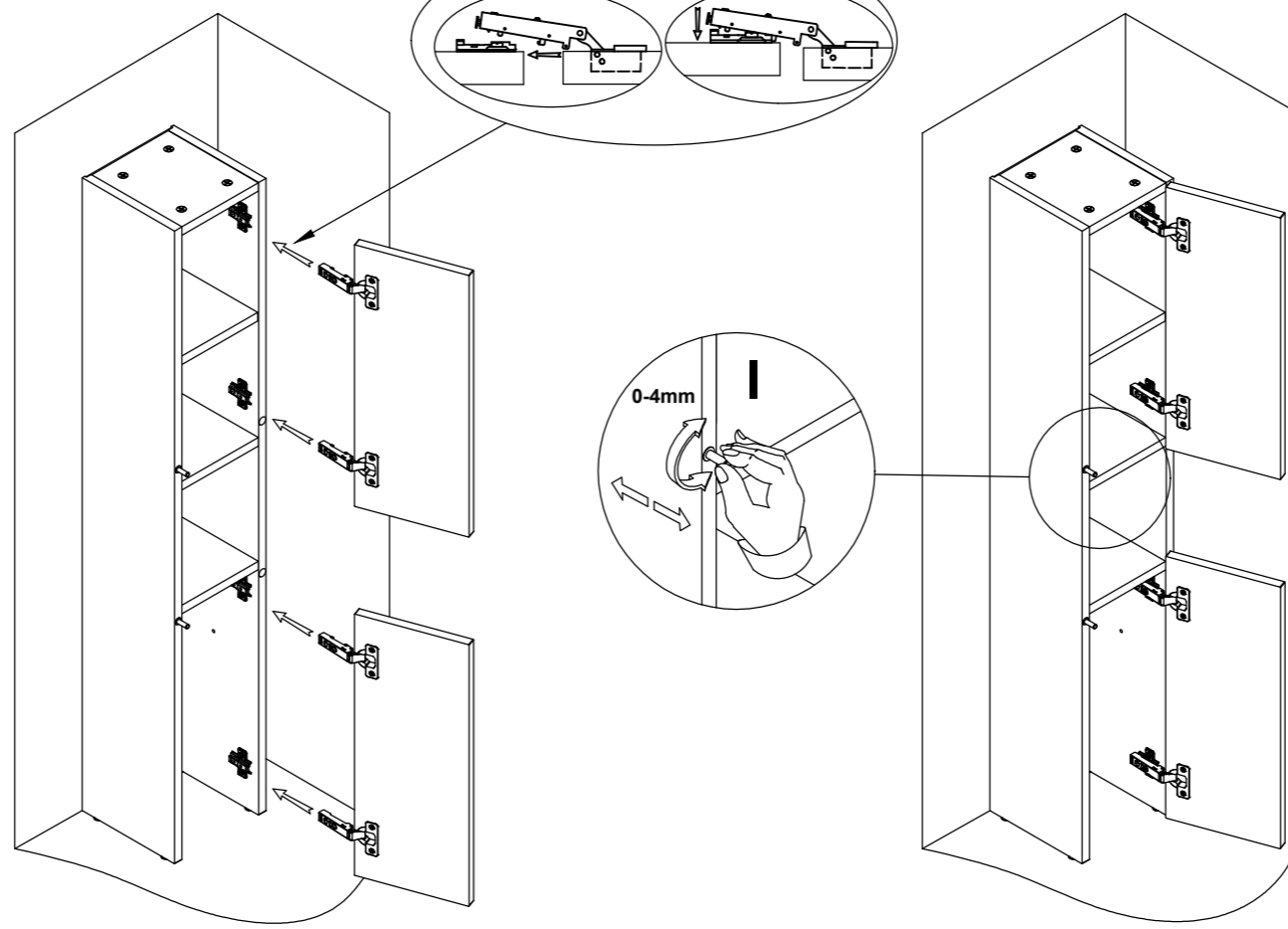
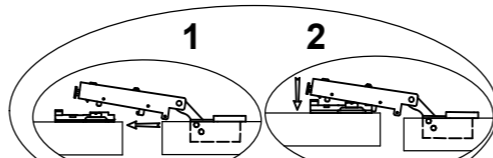

11

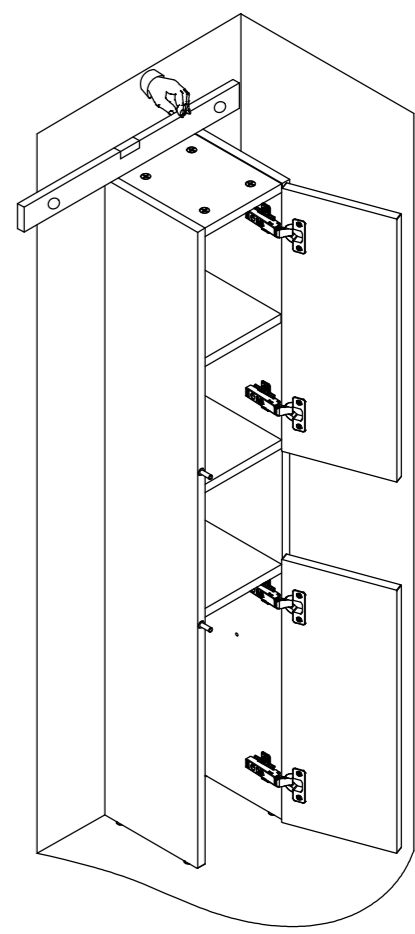
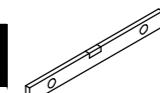

12

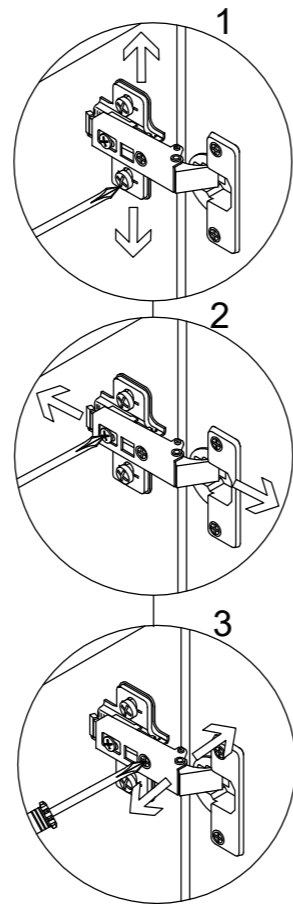
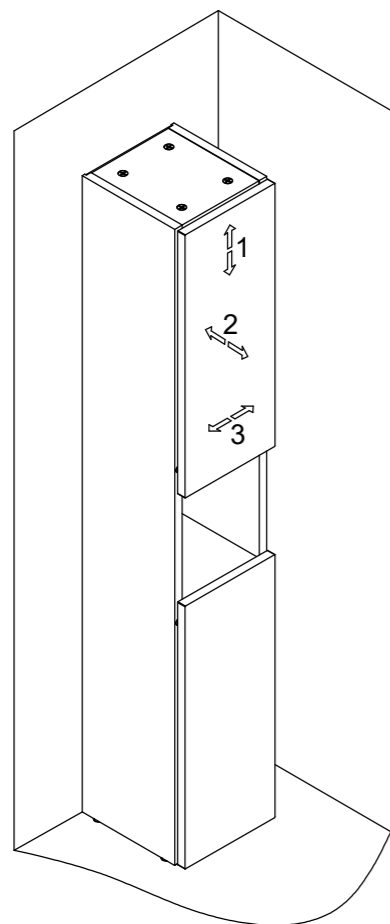
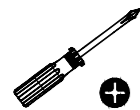

13

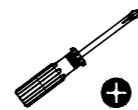

W2 $\varnothing 4 \times 30$
x2

